

# Bremen 40 (450x300)

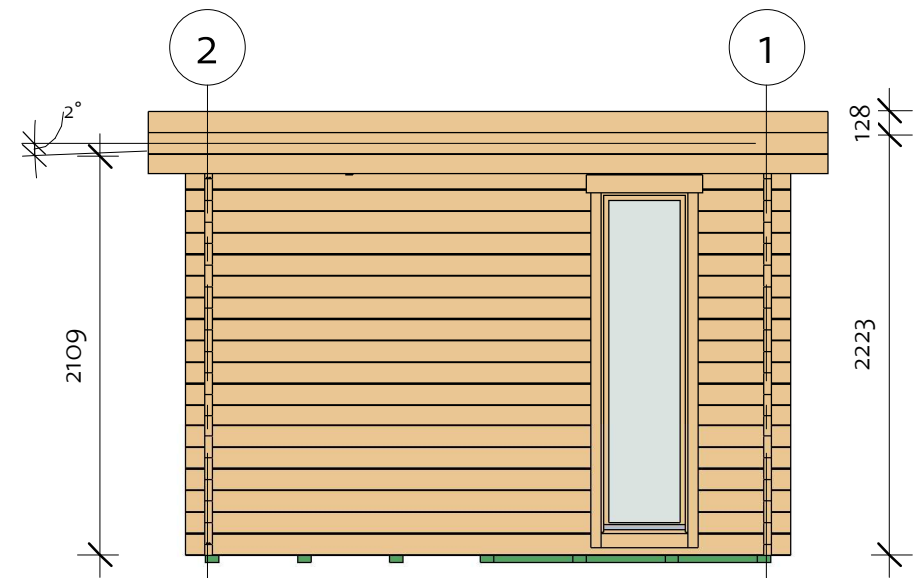

# Bremen 40 (450x300)

Foundation

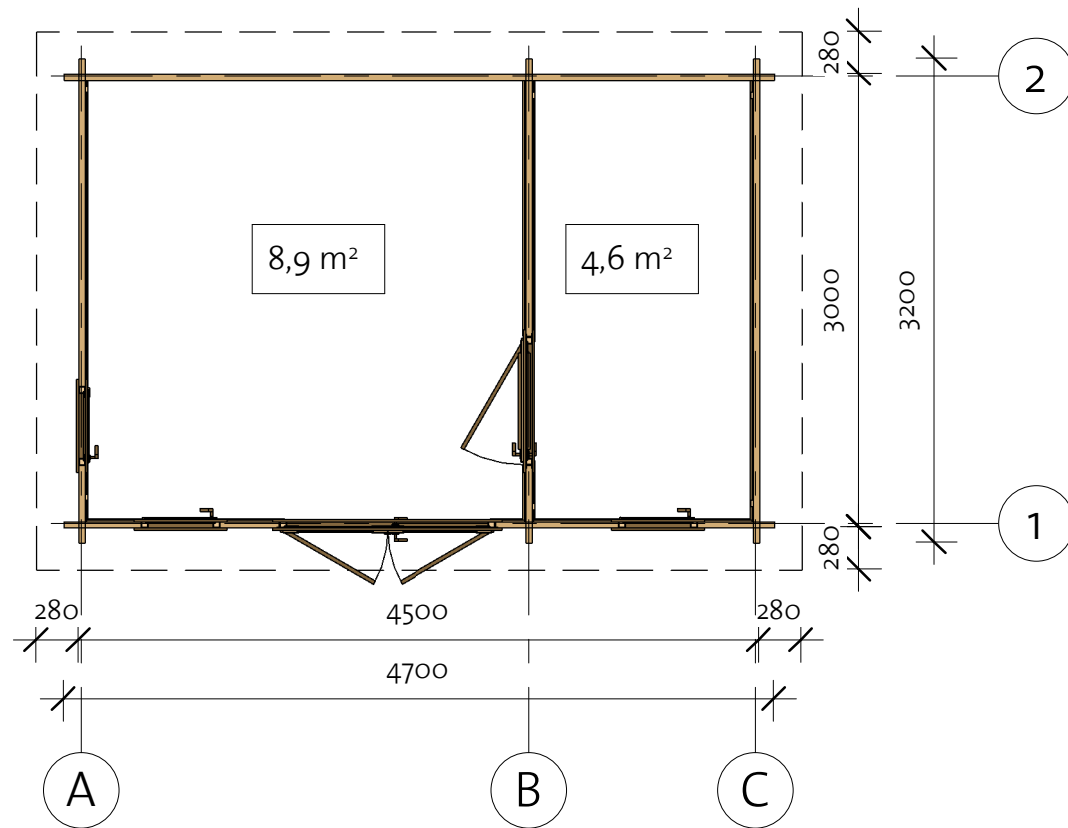
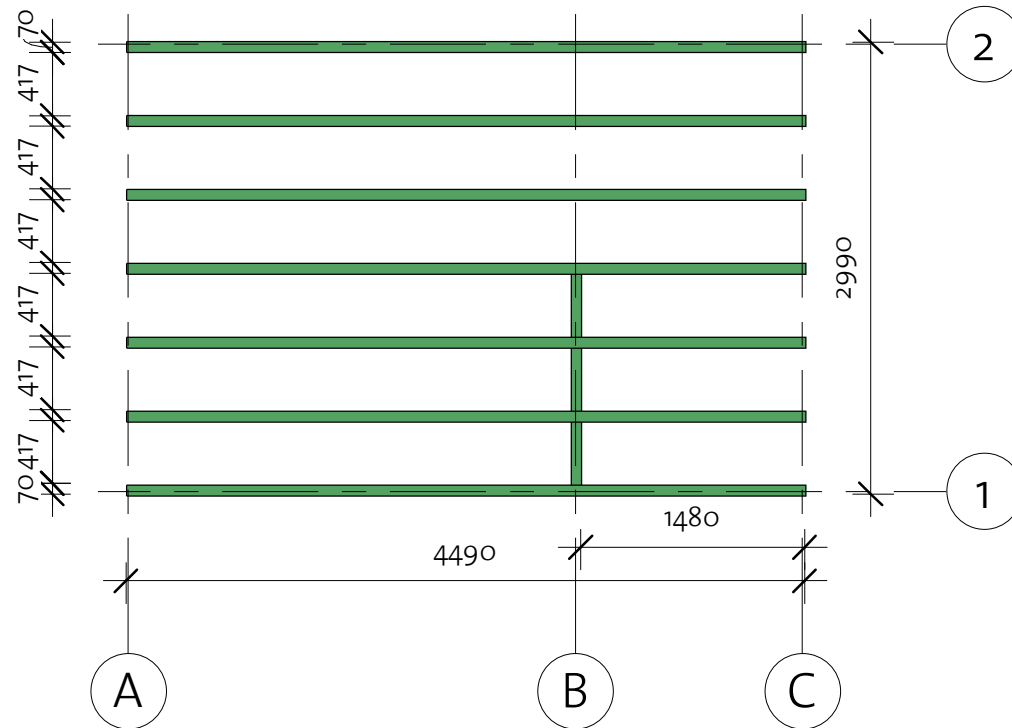

| Impregnated foundation beams |      |         |       |        |
|------------------------------|------|---------|-------|--------|
| Mark                         | Type | Profile | Count | Length |

|      |              |   |   |      |
|------|--------------|---|---|------|
| IFB1 | IFB<br>70x40 |  | 7 | 4490 |
| IFB2 | IFB<br>70x40 |   | 3 | 417  |



# Bremen 40 (450x300)

Floor Plan

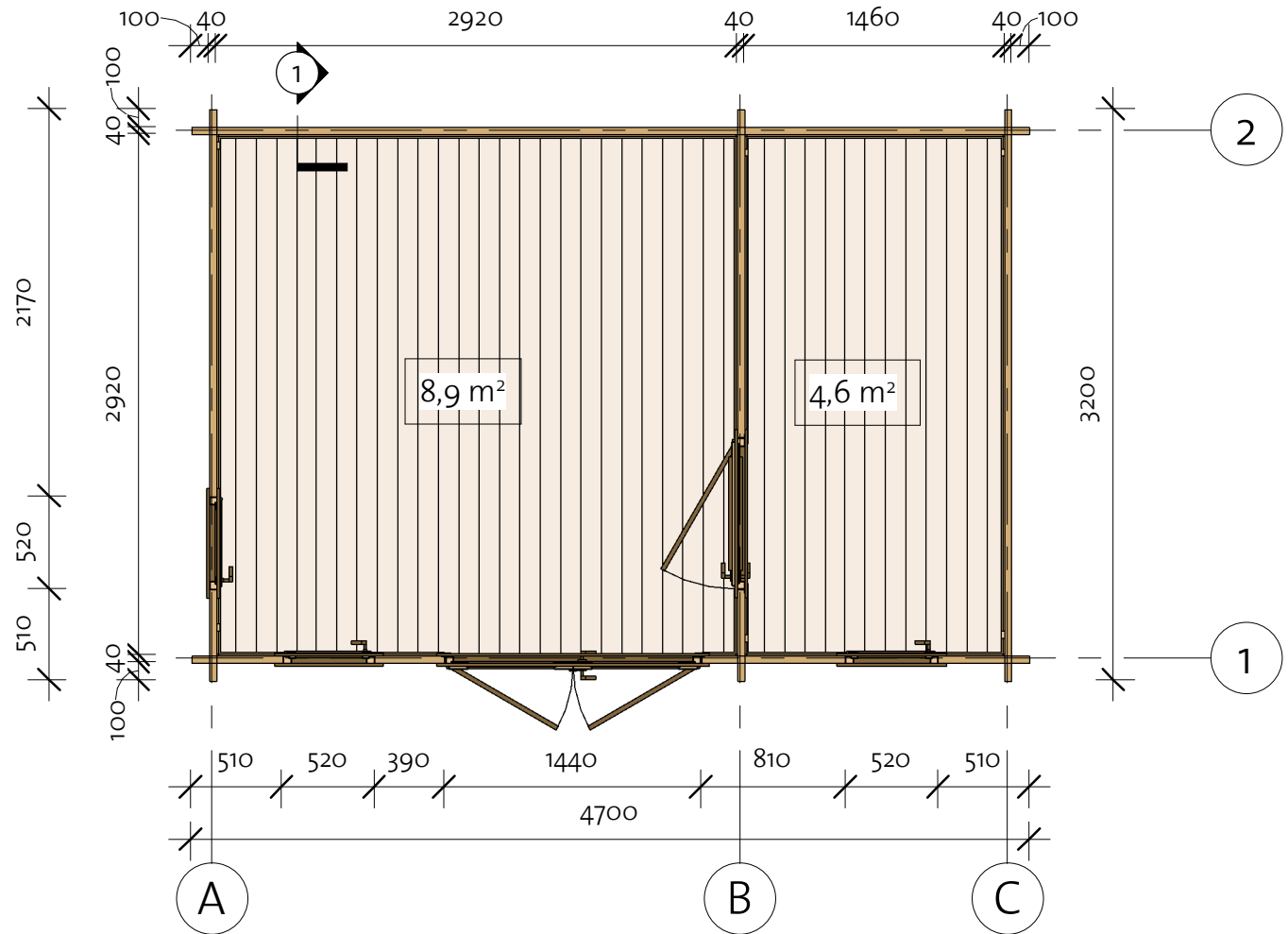
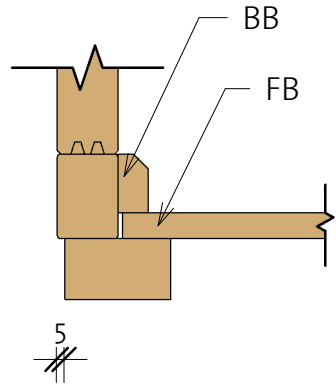
① Baseboard



Floor Schedule

| Mark | Type      | Profile   | Count | Length |
|------|-----------|---|-------|--------|
| FB   | FB 17x114 |  | 40    | 2914   |
| BB1  | BB 20x40  |  | 2     | 4500   |
| BB2  | BB 20x40  |   | 4     | 3000   |

91804244\_230614

# Bremen 40 (450x300)

Wall 1

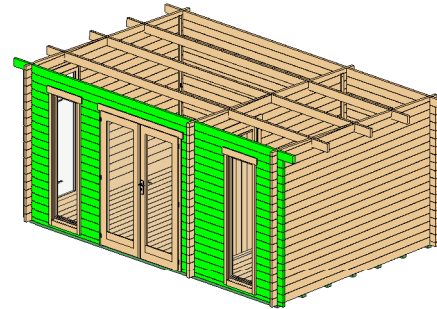

| Wall 1 |         |       |            |
|--------|---------|-------|------------|
| Mark   | Profile | Count | Cut Length |

|       |        |    |      |
|-------|--------|----|------|
| 1BL-1 | 40x57  | 1  | 1420 |
| 1BL-2 | 40x57  | 1  | 1840 |
| 1LG-1 | 40x114 | 17 | 390  |
| 1LG-2 | 40x114 | 34 | 510  |
| 1LG-3 | 40x114 | 17 | 810  |
| 1LG-4 | 40x114 | 1  | 4700 |
| 1TL-1 | 40x114 | 1  | 5060 |

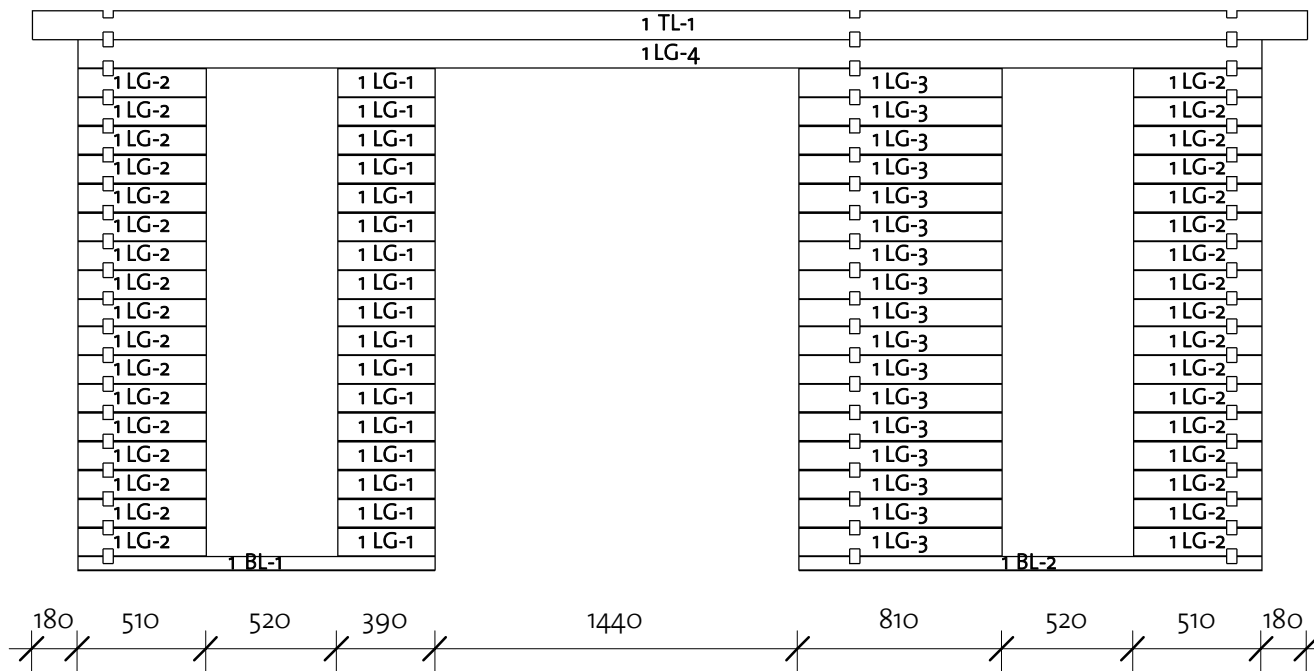

| Log Profile Wall 1 |         |
|--------------------|---------|
| Profile            | Profile |

|        |  |
|--------|--|
| 40x57  |  |
| 40x114 |  |
| 40x114 |  |



# Bremen 40 (450x300)

Wall A

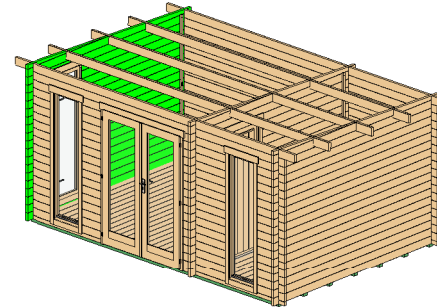

| Wall A |         |       |            |
|--------|---------|-------|------------|
| Mark   | Profile | Count | Cut Length |

|        |        |    |      |
|--------|--------|----|------|
| ALG-1  | 40x114 | 16 | 510  |
| ALG-2* | 40x114 | 1  | 1580 |
| ALG-3  | 40x114 | 16 | 2170 |
| ALG-4* | 40x114 | 1  | 3200 |
| ALG-5* | 40x114 | 1  | 3200 |
| ALG-6  | 40x114 | 1  | 3200 |

\* Gable - delivered premounted

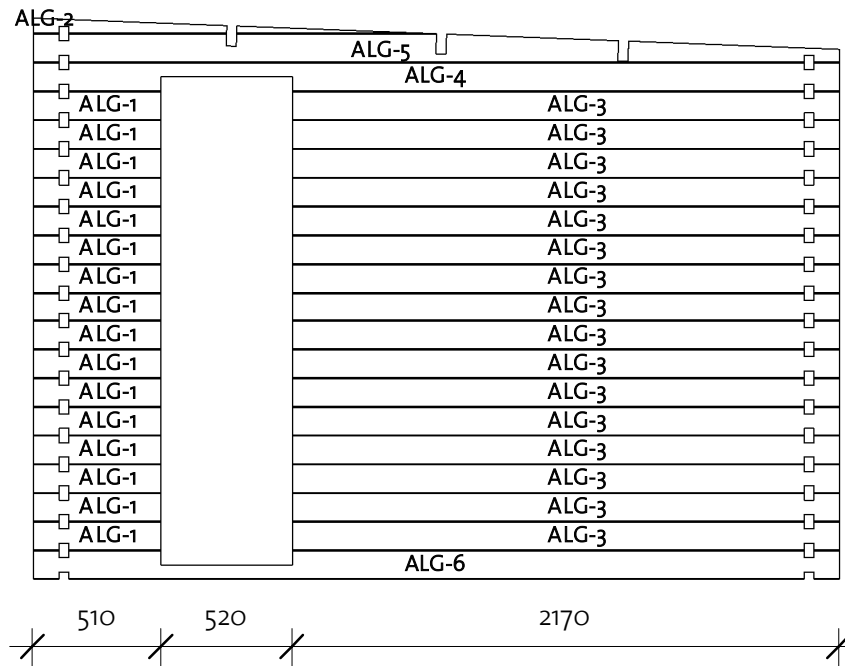

| Log Profile Wall A |         |
|--------------------|---------|
| Profile            | Profile |

|        |  |
|--------|--|
| 40x114 |  |
|--------|--|

# Bremen 40 (450x300)

Wall B

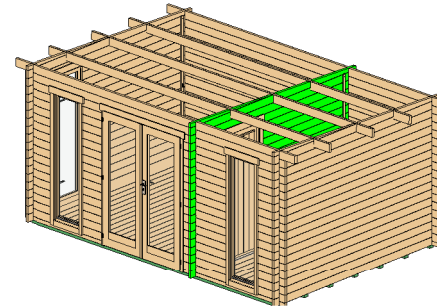

| Wall B |         |       |            |
|--------|---------|-------|------------|
| Mark   | Profile | Count | Cut Length |

|        |        |    |      |
|--------|--------|----|------|
| BLG-1  | 40X114 | 17 | 510  |
| BLG-2* | 40X114 | 1  | 1580 |
| BLG-3  | 40X114 | 17 | 1840 |
| BLG-4* | 40X114 | 1  | 3200 |
| BLG-5* | 40X114 | 1  | 3200 |

\* Gable - delivered premounted

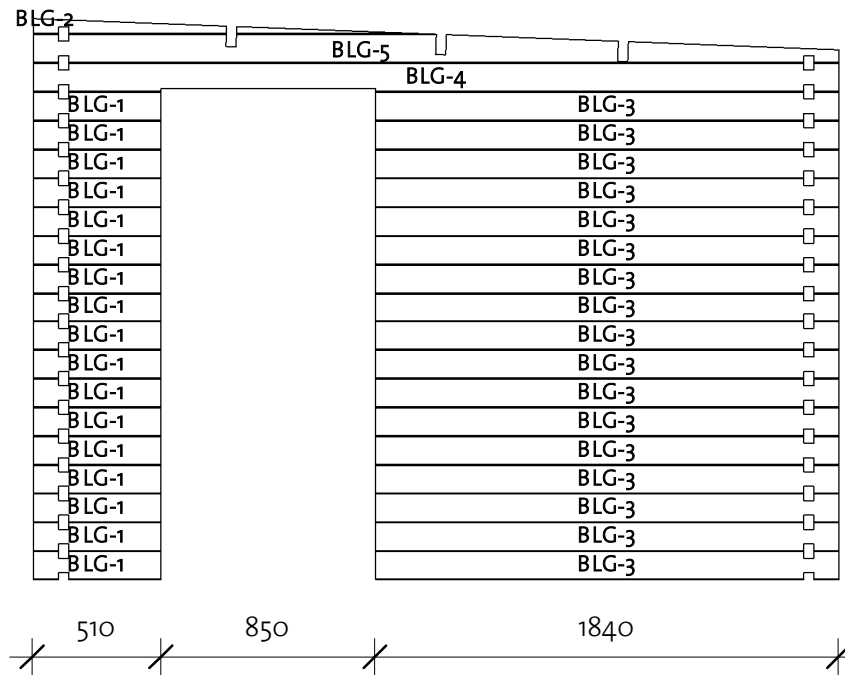

| Log Profile Wall B |         |
|--------------------|---------|
| Profile            | Profile |

|        |  |
|--------|--|
| 40X114 |  |
|--------|--|

# Bremen 40 (450x300)

Wall C

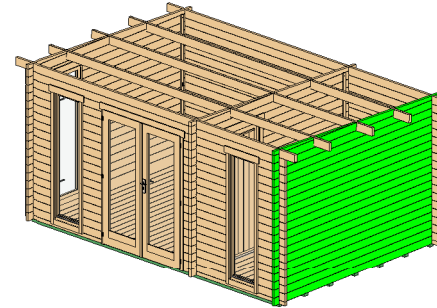

| Wall C |         |       |            |
|--------|---------|-------|------------|
| Mark   | Profile | Count | Cut Length |

|        |        |    |      |
|--------|--------|----|------|
| CLG-1* | 40x114 | 1  | 1580 |
| CLG-2  | 40x114 | 17 | 3200 |
| CLG-3* | 40x114 | 1  | 3200 |
| CLG-4* | 40x114 | 1  | 3200 |

\* Gable - delivered premounted

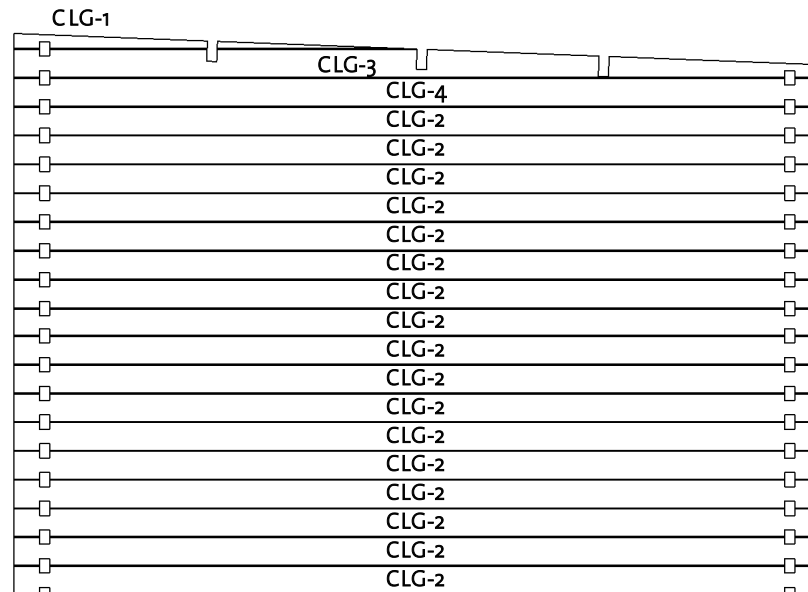

| Log Profile Wall C |         |
|--------------------|---------|
| Profile            | Profile |



|        |  |
|--------|--|
| 40x114 |  |
|--------|--|

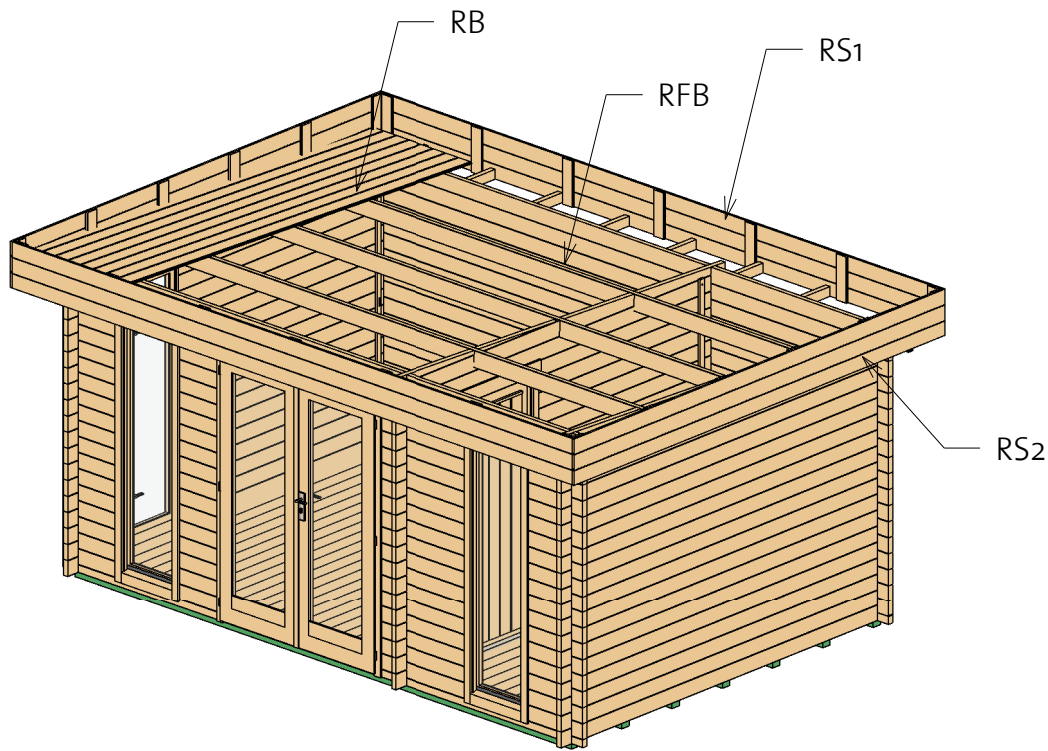

# Bremen 40 (450x300)

Roof 1

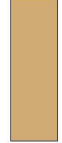

| Roof |                |   |       |        |
|------|----------------|---|-------|--------|
| Mark | Type           | Profile   | Count | Length |
| RB   | 17x114         |  | 45    | 3484   |
| RC   | 40x70          |  | 16    | 280    |
| RFB  | Beam<br>40x120 |  | 3     | 5060   |

| Roof Side Schedule |        |       |
|--------------------|--------|-------|
| Type               | Length | Count |
| RS1                | 5060   | 2     |
| RS2                | 3594   | 2     |

# Bremen 40 (450x300)

Roof 2

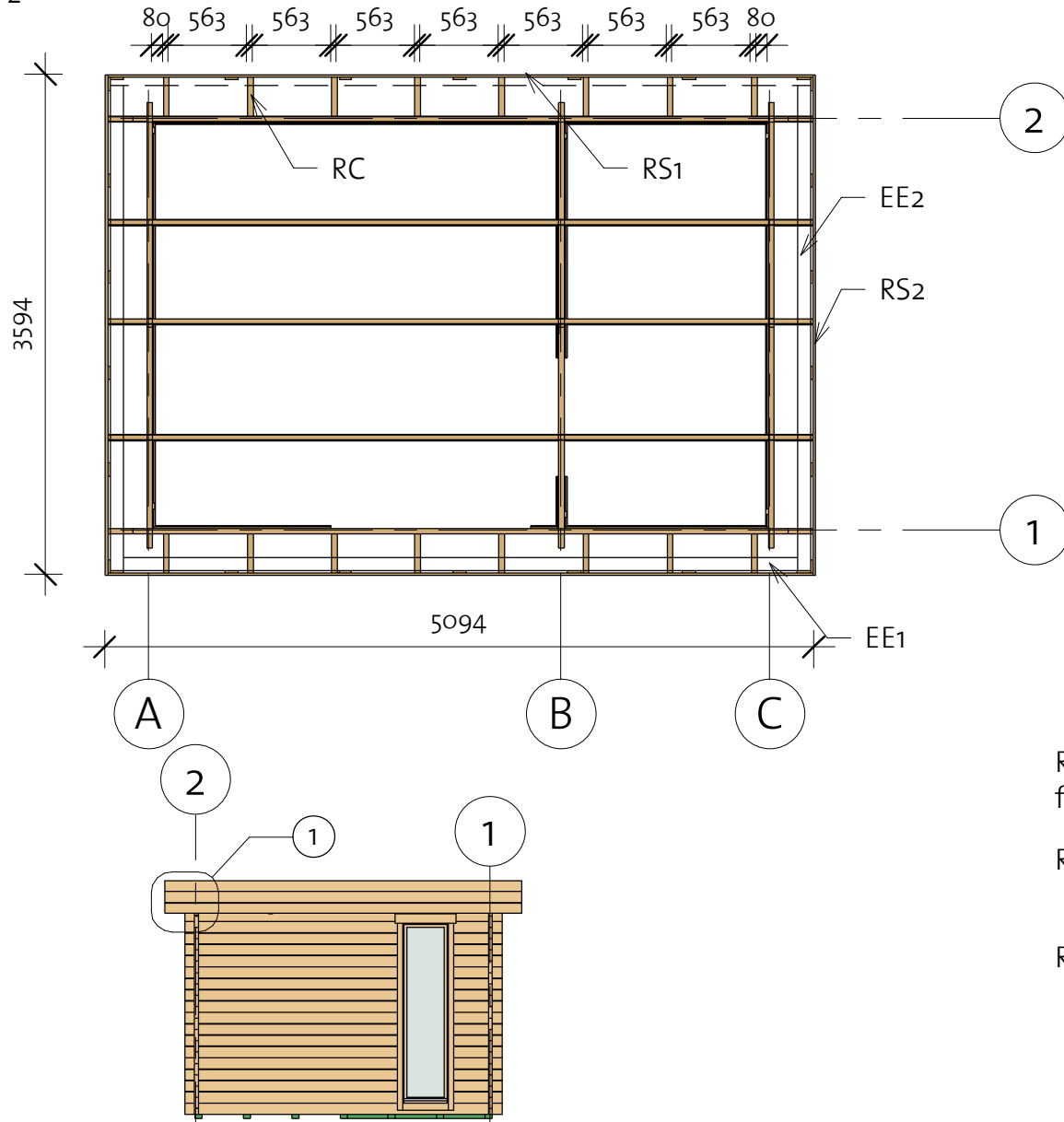

| Fascia Schedule |                   |         |       |        |
|-----------------|-------------------|---------|-------|--------|
| Mark            | Type              | Profile | Count | Length |
| EE1             | Eave Edging 18x95 |         | 1     | 4835   |
| EE2             | Eave Edging 18x95 |         | 2     | 3485   |

① West Roof - Callout 1

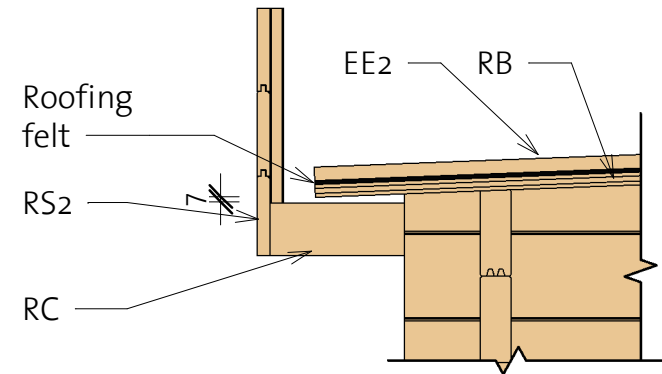

# Bremen 40 (450x300)

Extras

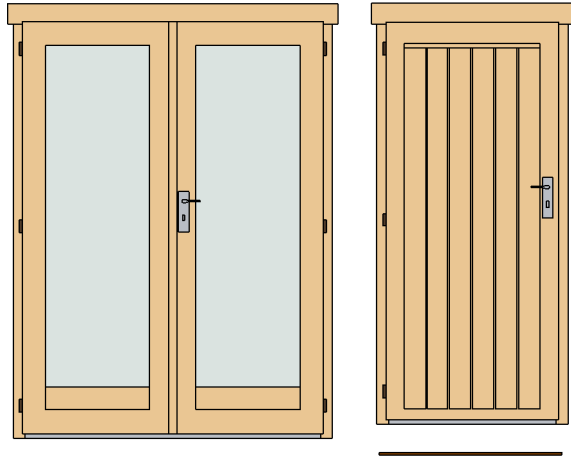

| Door Schedule |   |       |        |       |
|---------------|---|-------|--------|-------|
| Model         | Type                                    | Width | Height | Count |
| CDD3R         | Classic double door 3, full glass right | 1425  | 1955   | 1     |
| CD5L          | Classic door 5, wood left               | 840   | 1890   | 1     |

|    |                  |    |    |   |
|----|------------------|----|----|---|
| DB | Door beam 850 mm | 40 | 12 | 1 |
|----|------------------|----|----|---|

|      |                          |    |    |   |
|------|--------------------------|----|----|---|
| DCB8 | Door Crossbar 8 optional | -- | -- | 2 |
|------|--------------------------|----|----|---|

| Window Schedule |      |       |        |       |
|-----------------|------|-------|--------|-------|
| Mark            | Type | Width | Height | Count |

|       |                         |     |      |   |
|-------|-------------------------|-----|------|---|
| CW21R | Classic window 21 right | 515 | 1890 | 3 |
|-------|-------------------------|-----|------|---|

|      |                             |    |    |   |
|------|-----------------------------|----|----|---|
| WCB8 | Windows Crossbar 8 optional | -- | -- | 3 |
|------|-----------------------------|----|----|---|

| Type            | Count | Length |
|-----------------|-------|--------|
| Windboard 18x40 | 6     | 2200   |

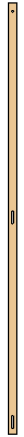

| Fasteners/Extras |      |       |
|------------------|------|-------|
| Name             | Type | Count |

|          |            |     |
|----------|------------|-----|
| Hitblock | 300-400 mm |     |
| Bolts    | M8 x 70    | 12  |
| Nails    | 1,4 x 40   | 50  |
| Screws   | 5,0 x 70   | 55  |
| Screws   | 6,0 x 140  | 60  |
| Screws   | 4,0 x 40   | 670 |

- \* Windows intended for tilt opening only!
- \* Fenster zur Eröffnung nur zum Kippen vorgesehen!
- \* Aknad on ette nähtud ainult kaldu avamiseks!

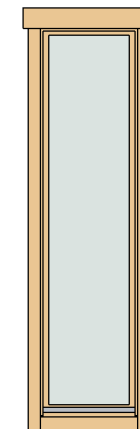



# Bremen 40 (450x300)

## List of all items 1

| Impregnated foundation beams |      |         |       |        |
|------------------------------|------|---------|-------|--------|
| Mark                         | Type | Profile | Count | Length |

|      |              |   |   |      |
|------|--------------|---|---|------|
| IFB1 | IFB<br>70x40 |  | 7 | 4490 |
| IFB2 | IFB<br>70x40 |   | 3 | 417  |

| Roof |      |         |       |        |
|------|------|---------|-------|--------|
| Mark | Type | Profile | Count | Length |

|     |                |   |    |      |
|-----|----------------|---|----|------|
| RB  | 17x114         |    | 45 | 3484 |
| RC  | 40x70          |  | 16 | 280  |
| RFB | Beam<br>40x120 |  | 3  | 5060 |

| Roof Side Schedule |        |       |
|--------------------|--------|-------|
| Type               | Length | Count |

|     |      |   |
|-----|------|---|
| RS1 | 5060 | 2 |
| RS2 | 3594 | 2 |

| Floor Schedule |      |         |       |        |
|----------------|------|---------|-------|--------|
| Mark           | Type | Profile | Count | Length |

|    |           |   |    |      |
|----|-----------|---|----|------|
| FB | FB 17x114 |  | 40 | 2914 |
|----|-----------|---|----|------|

|     |             |   |   |      |
|-----|-------------|---|---|------|
| BB1 | BB<br>20x40 |  | 2 | 4500 |
| BB2 | BB<br>20x40 |   | 4 | 3000 |

| Fascia Schedule |      |         |       |        |
|-----------------|------|---------|-------|--------|
| Mark            | Type | Profile | Count | Length |

|     |                         |   |   |      |
|-----|-------------------------|---|---|------|
| EE1 | Eave<br>Edging<br>18x95 |  | 1 | 4835 |
| EE2 | Eave<br>Edging<br>18x95 |  | 2 | 3485 |

# Bremen 40 (450x300)

## List of all items 2

| Wall 1 |         |       |            |
|--------|---------|-------|------------|
| Mark   | Profile | Count | Cut Length |

|       |        |    |      |
|-------|--------|----|------|
| 1BL-1 | 40x57  | 1  | 1420 |
| 1BL-2 | 40x57  | 1  | 1840 |
| 1LG-1 | 40x114 | 17 | 390  |
| 1LG-2 | 40x114 | 34 | 510  |
| 1LG-3 | 40x114 | 17 | 810  |
| 1LG-4 | 40x114 | 1  | 4700 |
| 1TL-1 | 40x114 | 1  | 5060 |

| Wall A |         |       |            |
|--------|---------|-------|------------|
| Mark   | Profile | Count | Cut Length |

|        |        |    |      |
|--------|--------|----|------|
| ALG-1  | 40x114 | 16 | 510  |
| ALG-2* | 40x114 | 1  | 1580 |
| ALG-3  | 40x114 | 16 | 2170 |
| ALG-4* | 40x114 | 1  | 3200 |
| ALG-5* | 40x114 | 1  | 3200 |
| ALG-6  | 40x114 | 1  | 3200 |

| Wall C |         |       |            |
|--------|---------|-------|------------|
| Mark   | Profile | Count | Cut Length |

|        |        |    |      |
|--------|--------|----|------|
| CLG-1* | 40x114 | 1  | 1580 |
| CLG-2  | 40x114 | 17 | 3200 |
| CLG-3* | 40x114 | 1  | 3200 |
| CLG-4* | 40x114 | 1  | 3200 |

| Wall 2 |         |       |            |
|--------|---------|-------|------------|
| Mark   | Profile | Count | Cut Length |

|       |        |    |      |
|-------|--------|----|------|
| 2BL-1 | 40x57  | 1  | 4700 |
| 2LG-1 | 40x114 | 17 | 4700 |
| 2TL-1 | 40x114 | 1  | 5060 |

| Wall B |         |       |            |
|--------|---------|-------|------------|
| Mark   | Profile | Count | Cut Length |

|        |        |    |      |
|--------|--------|----|------|
| BLG-1  | 40x114 | 17 | 510  |
| BLG-2* | 40x114 | 1  | 1580 |
| BLG-3  | 40x114 | 17 | 1840 |
| BLG-4* | 40x114 | 1  | 3200 |
| BLG-5* | 40x114 | 1  | 3200 |

\* Gable - delivered premounted

| Log profiles |         |
|--------------|---------|
| Profile      | Profile |

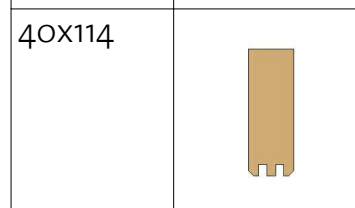
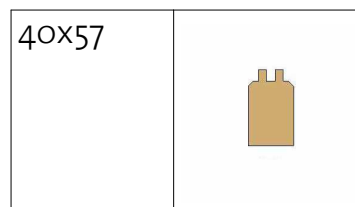

| Log profiles |         |
|--------------|---------|
| Profile      | Profile |

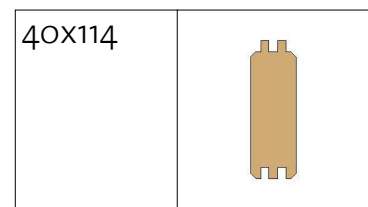

# Windboard

① Windboard Assembly 1



② Windboard Assembly 2

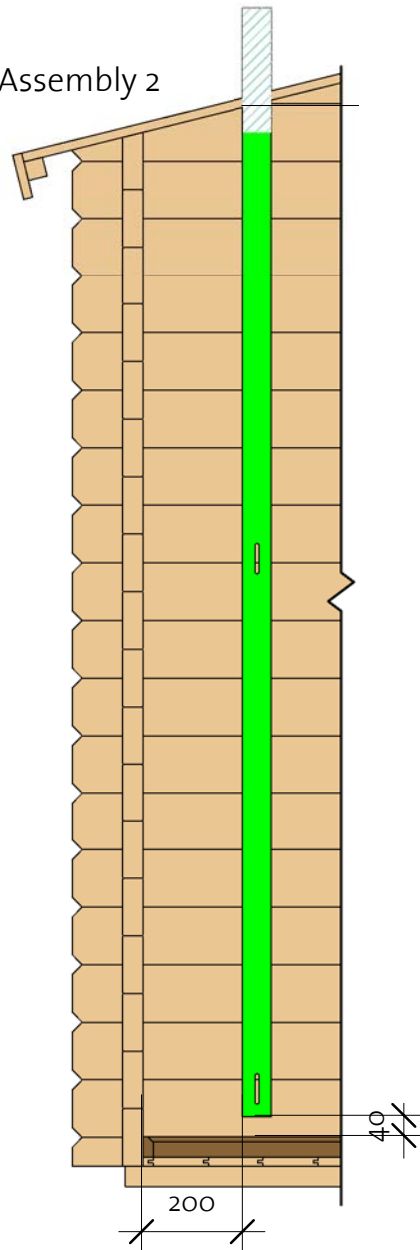

③ Windboard Assembly 3

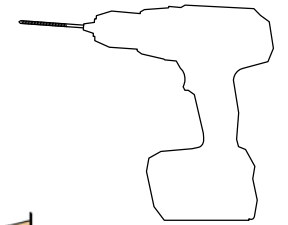
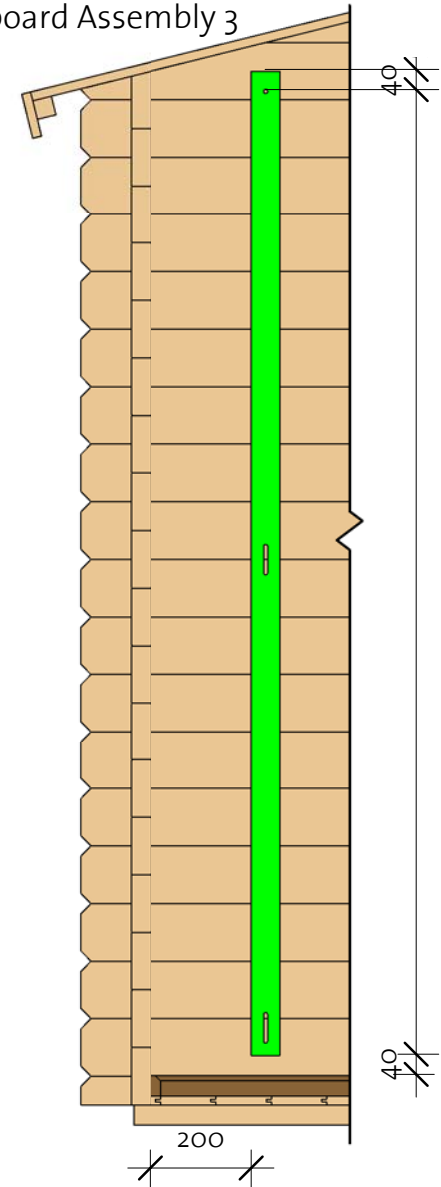

Ø 8mm